

TRANSFLUID



TRANSFLUID®

industrial & marine



drive with us

KPTO

GIUNTI IDRODINAMICI A SVUOTAMENTO
per motori endotermici

GIUNTI IDRODINAMICI SERIE KPTO per motori endotermici

DESCRIZIONE

Il **KPTO** è un giunto idrodinamico a riempimento variabile contenuto in un carter con flangiatura SAE, sostenuto dal motore Diesel. Il sistema unisce le caratteristiche tecniche della presa di forza tradizionale alle prestazioni del giunto idrodinamico.

La pompa di alimentazione integrata è trascinata direttamente dal motore Diesel. Il sistema comprende una elettrovalvola comandata a distanza che consente, in posizione ON l'alimentazione del giunto, in posizione OFF il rapido svuotamento attraverso i fori periferici. La lubrificazione forzata dei cuscinetti è in entrambi i casi assicurata.

Sono disponibili giunti della gamma **KPTO** per potenze fino a 1000 kW.

Il volano viene collegato all'albero d'ingresso del **KPTO** per mezzo di un giunto ad elevata elasticità torsionale. L'albero di uscita è collegato con la macchina condotta tramite una vasta scelta di giunti di allineamento, alberi cardanici o pulegge.

Accessori: filtro olio con termometro e manometro, elettrovalvola, pressostato e termostato, indicatori di livello, pompa d'alimento.

A richiesta: scambiatore acqua-olio o radiatore, valvole di scarico rapido, puleggia in uscita, giunti d'allineamento elastici o superelastici.

SCHEMA DI FUNZIONAMENTO

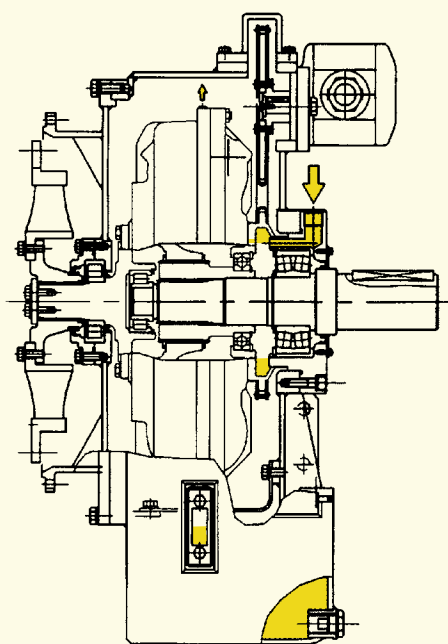

Giri/min ↕	POTENZA MOTORE DIESEL (kW)				
	↔ Dimensioni (mm)				
	15	19	21	24	27
1000	-	70	100	150	220
1200	-	90	150	220	300
1500	65	160	230	315	570
1800	85	275	400	545	1000
2200	155	330	470	650	-
2600	200	400	-	-	-

CARATTERISTICHE

Il giunto idrodinamico a svuotamento consente di disconnettere il motore dal carico. Ne risultano notevoli vantaggi:

- avviamento del motore a vuoto
- avviamento dolce del carico
- assorbimento dei sovraccarichi
- assorbimento delle vibrazioni torsionali
- grande capacità di carico radiale
- controllo della coppia erogata in avviamento
- nessuno slittamento delle cinghie
- comando a distanza per mezzo dell'elettrovalvola
- posizionamento del carico
- pompa d'alimento, filtro olio ed elettrovalvola sistemati all'esterno per facilitarne la manutenzione
- lunga durata, non essendoci organi di frizione soggetti ad usura.

APPLICAZIONI

- mulini, frantumatori, truciolatori
- nastri trasportatori
- pompe centrifughe, volumetriche e compressori
- propulsione navale
- generatori
- ventilatori

CIRCUITO IDRAULICO

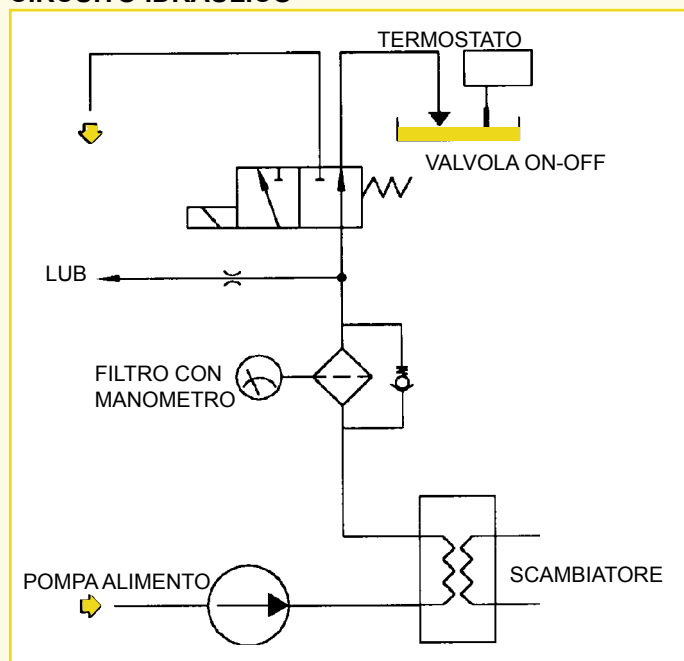

Per calcolare la portata di olio e di acqua nello scambiatore, usare le seguenti:

$$\text{acqua (l/min)} = \frac{\text{potenza (kW)}}{50} \times 8$$

$$\text{olio (l/min)} = \frac{\text{potenza (kW)}}{50} \times 10$$

Queste formule si basano sui seguenti dati:

Entrata olio scamb. = 110°C Uscita olio scamb. = 100°C
Entrata acqua scamb. = 85°C Uscita acqua scamb. = 90°C

Può essere usata l'acqua di raffreddamento del motore.

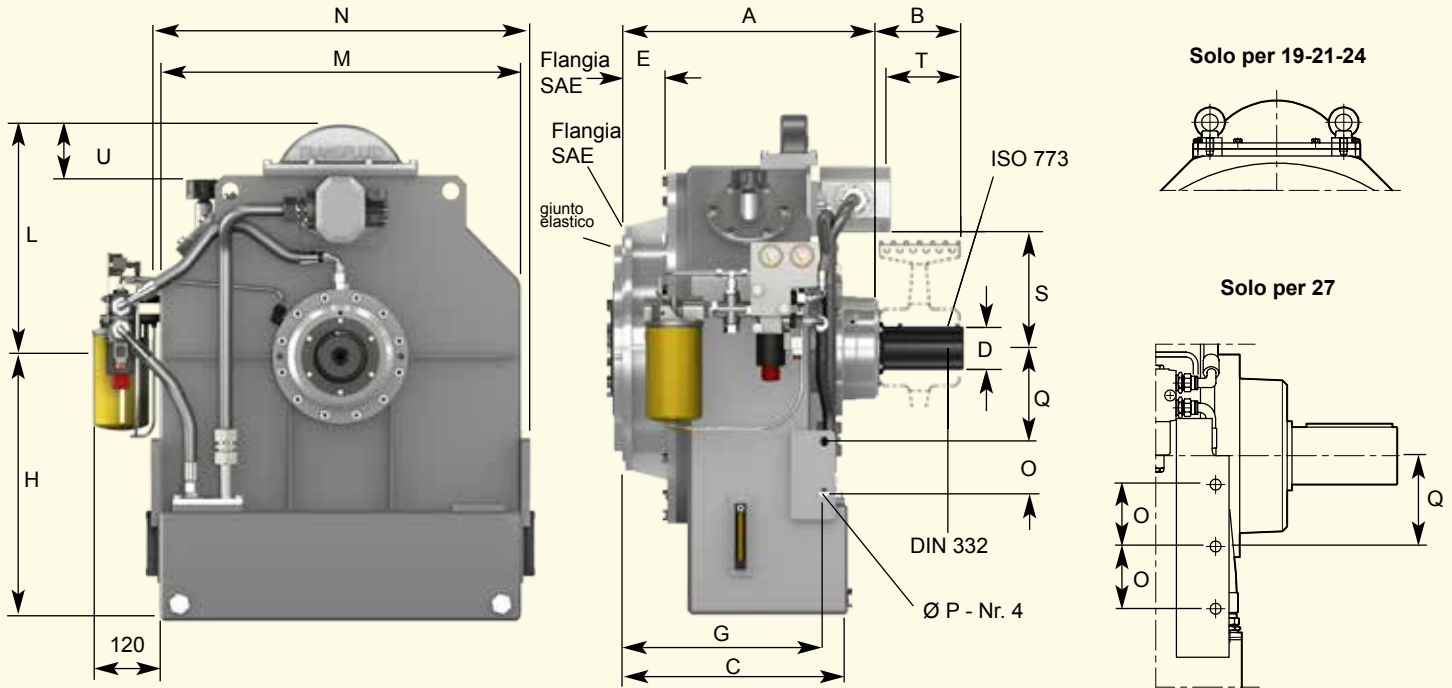

Taglia

Dimensioni (mm)

	A	B	C	D	E	G	H	L	M	N
15	414	130	430	70	61	362	440	395	560	590
19	455	150	450	80	98	406	500	420	670	700
21	517	180	512	100	105	458	600	480	820	860
24	583	180	502	100	95	448	600	526	820	860
27	710-726*	220	605-621*	120	123-139*	550-566*	675	445	890	940

Taglia

Dimensioni (mm)

	O	P	Q	S	T	U	Coprivolano SAE	Volano SAE	Peso (kg) senza olio	Olio (l)
15	65	17	135	205	66.5	115	2-1	11.5-14	250	28
19	80	19	155	228	68	85	1	14	310	35
21	115	21	210	260	87	115	1-0	14-18	475	65
24	115	21	210	260	163	70	1-0	14-18	550	65
27	130	23	190	-	-	-	0-00	18-21*	800	87

* Dimensioni per volano 21*

Per carichi radiali ammissibili contattare Transfluid

Dimensioni non impegnative





















FRANTUMATORE



PROPULSIONE MARINA

EUROPE

-  **AUSTRIA**
ASC GMBH
4470 Enns
-  **BELGIUM - LUXEMBURG**
TRANSFLUID FRANCE s.a.r.l.
38110 Rochetoirin
Ph. +33 9 75635310
Fax +33 4 26007959
tffrance@transfluid.it
-  **CZECH REPUBLIC**
TESPO ENGINEERING s.r.o.
602 00 Brno
-  **DENMARK (Electric appl.)**
JENS S. TRANSMISSIONER A/S
DK 2635 ISHØJ
-  **ENGLAND & IRELAND**
MARINE AND INDUSTRIAL TRANS. LTD.
Queenborough Kent me11 5ee
-  **FINLAND (Electric appl.)**
OY JENS S. AB
02271 Espoo
-  **FINLAND (Diesel appl.)**
TRANS-AUTO AB
151 48 Södertälje
-  **FRANCE**
TRANSFLUID FRANCE s.a.r.l.
38110 Rochetoirin
Ph. +33 9 75635310
Fax +33 4 26007959
tffrance@transfluid.it
-  **GERMANY - HOLLAND**
TRANSFLUID GERMANY GmbH
D-48529 Nordhorn
Ph. +49 5921 7288808
Fax +49 5921 7288809
tfgermany@transfluid.it
-  **NORWAY (Diesel appl.)**
K GK Norge AS
0664 Oslo
-  **POLAND**
SENOMA LTD
PL40-153 Katowice
-  **PORTUGAL**
REDVARIO LDA
2735-469 Cacem
-  **RUSSIA - BELARUS - KAZAKHSTAN**
TRANSFLUID OOO
143100 Moscow
Ph. +7 495 7782042
Mob. +7 926 8167357
tfrussia@transfluid.it
-  **SLOVENIA - BOSNIA - CROATIA
SERBIA**
VIA INTERNATIONAL d.o.o.
1241 Kamnik
-  **SPAIN**
TECNOTRANS BONFIGLIOLI S.A.
08040 Barcelona
-  **SWEDEN - ESTONIA - LATVIA
(Electric appl.)**
JENS S. TRANSMISSIONER AB
SE-601-19 Norrköping
-  **SWEDEN (Diesel appl.)**
TRANS-AUTO
SE 151-48 Södertälje
-  **TURKEY**
REMAS
81700 Tuzla Istanbul

AMERICA



-  **ARGENTINA**
ACOTEC S.A.
Villa Adelina - Buenos Aires
-  **BRAZIL**
SGI PTI
04461-050 Sao Paulo SP
-  **CHILE**
SCEM LTDA
Santiago Do Chile
-  **COLUMBIA**
A.G.P. REPRESENTACIONES LTDA
77158 Bogotà
-  **PERU'**
SCEM LTDA SUC. PERU
Lima 18
-  **U.S.A. - CANADA - MEXICO**
TRANSFLUID LLC
Auburn, GA30011
Ph. +1 770 822 1777
Fax +1 770 822 1774
tfusa@transfluid.it

 **AFRICA**

-  **ALGERIA - CAMEROUN - GUINEA
MAROCCO - MAURITANIA
SENEGAL - TUNISIA**
TRANSFLUID FRANCE s.a.r.l.
38110 Rochetoirin (France)
Ph. +33 9 75635310
Fax +33 4 26007959
tffrance@transfluid.it
-  **EGYPT**
INTERN.FOR TRADING & AGENCY (ITACO)
Nasr City (Cairo)
-  **SOUTH AFRICA
SUB SAHARAN COUNTRIES**
BMG BEARING MAN GROUP
Johannesburg
-  **OCEANIA
NEW ZELAND**
HENLEY ENGINEERING Ltd
Auckland

ASIA

-  **ASIA South East**
ATRAN TRANSMISSION PTE LTD
Singapore 608 579
-  **CHINA**
TRANSFLUID BEIJING TRADE CO. LTD
101300 Beijing
Ph. +86 10 60442301-2
Fax +86 10 60442305
tbtinfo@sina.com
-  **INDIA**
PROTOS ENGINEERING CO. PRIVATE LTD
600002 Tamilnadu Chennai
-  **INDONESIA**
PT. HIMALAYA EVEREST JAYA
Barat Jakarta 11710
-  **IRAN**
LEBON CO.
Tehran 15166
-  **IRAN (Oil & Gas appl.)**
EVANPALA Inc
Tehran 1433643115
-  **ISRAEL**
ELRAM ENGINEERING &
ADVANCED TECHNOLOGIES 1992 LTD
Emek Hefer 38800
-  **JAPAN**
ASAHI SEIKO CO. LTD.
Osaka 593
-  **KOREA**
KIWON CORP.
Pusan - South Korea
-  **TAIWAN**
FAIR POWER TECHNOLOGIES CO.LTD
105 Taipei
-  **THAILAND**
SYSTEM CORP. LTD.
Bangkok 10140
-  **UAE - SAUDI ARABIA - KUWAIT - OMAN
BAHRAIN - YEMEN - QATAR**
NICO INTERNATIONAL U.A.E.
Dubai

-  **FILIALE TRANSFLUID**
-  **SERVIZIO ASSISTENZA**
-  **UFFICIO DI RAPPRESENTANZA**

Global web site: www.transfluid.eu
E-commerce web site: www.buy-transfluid.com

AGENTE DI ZONA